

# Three-layers kusudama "Fractal"

by Valentina Gonchar, Russia

translation from Russian by Olga R. Gonchar

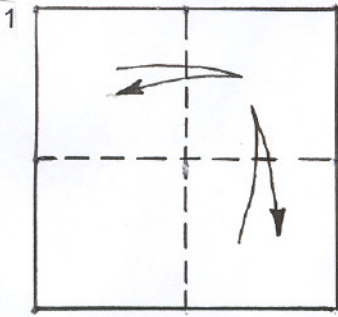

1 A standard sheet square (21x21cm)

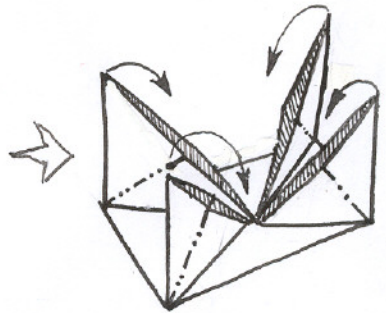
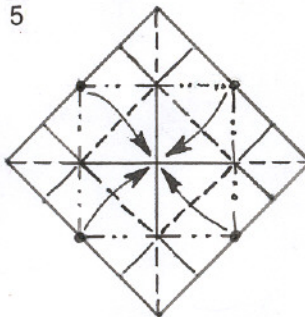
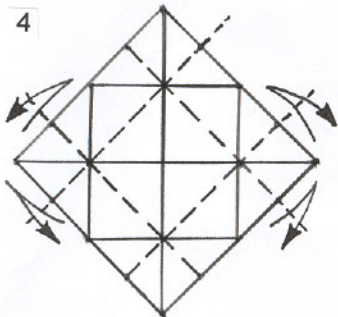
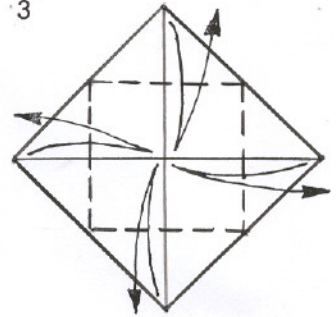
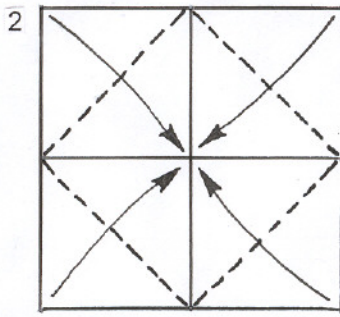

5 Lift corners to top, connect middles of sides at the center of the sheet

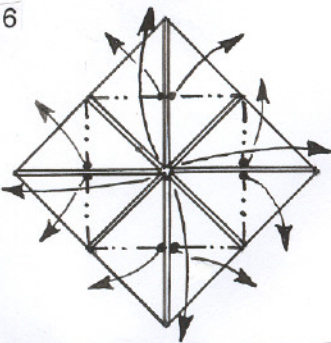

6 Simultaneously do folding "mountain" and lift corners from center

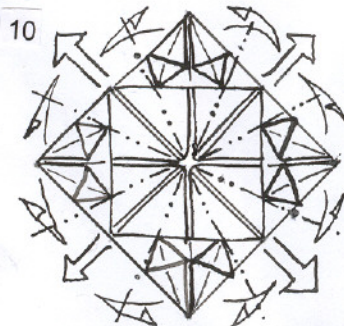
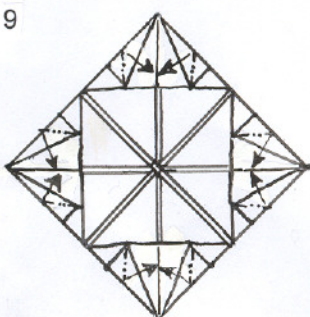
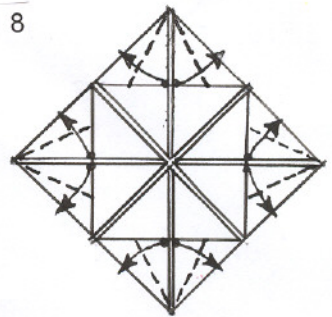
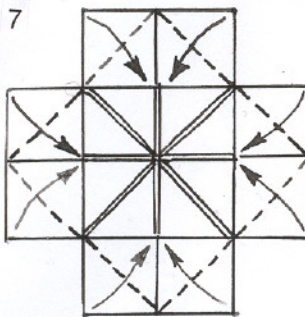

10 Fold by "mountain" and turn off triangles from back

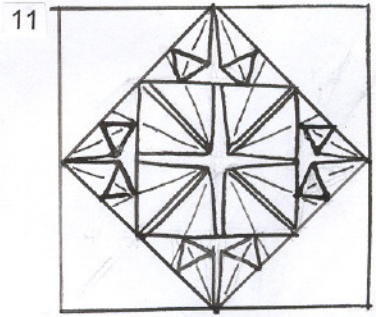

11 Detail №1. There are 6 such details needed

Again make 6 such details from squares 15×15 cm – (this will be detail №2) and 6 such details from squares 10,5×10,5 cm (detail №3).

In each detail №3 you should lock corners meeting in center by Kawasaki node. For our model there are 6 such nodes needed. Kawasaki node is made of 7×7 cm square.

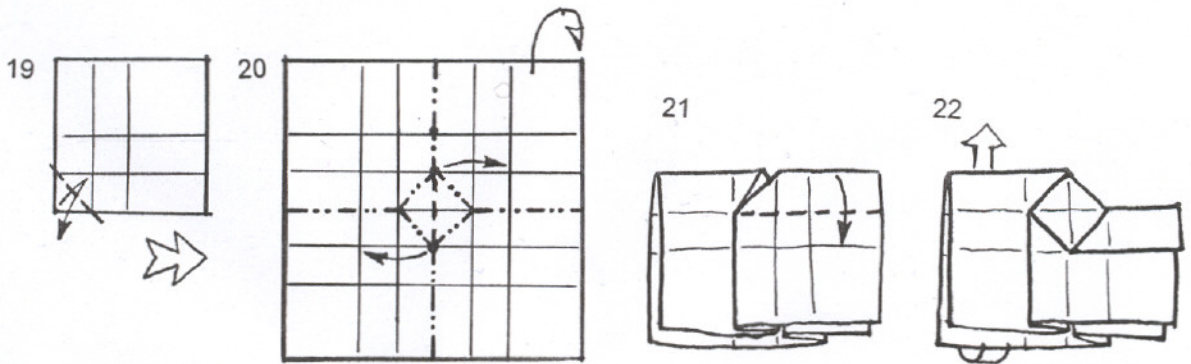
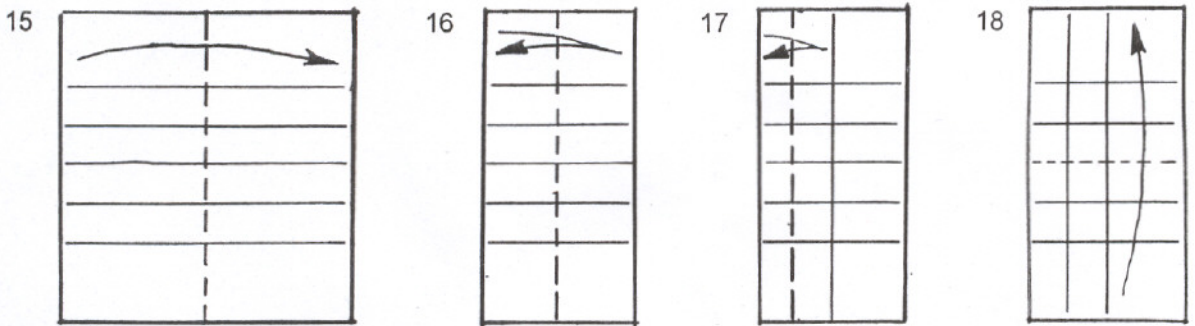
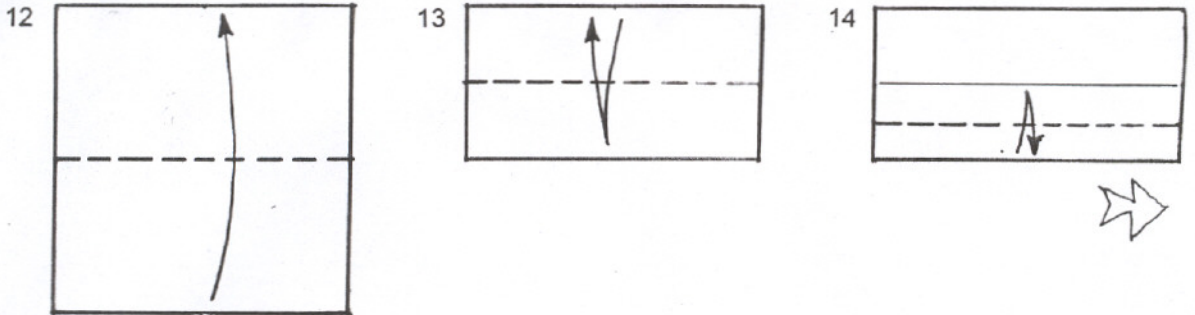

Do the folding simultaneously with turning

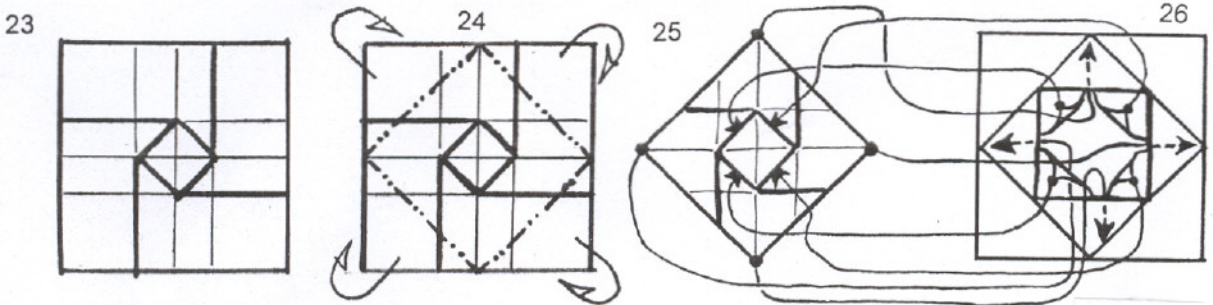

Kawasaki node

detail №3



Raise a little corners meeting in center in detail №3 and put the Kawasaki node under them; then put the ends of the corners under square-sides of Kawasaki node.

You can also join the detail №3 with the Kawasaki node the other way: unfold the detail №3 till position 5, put the Kawasaki node in the middle of it and combine centers and corners; then fold the detail №3 in reverse order till position 10.

Bend back a little the square-side of the detail №3 – a small square-side of the Kawasaki node must be seen – and put there the central corner of the detail №3. Do the same with the other three corners.

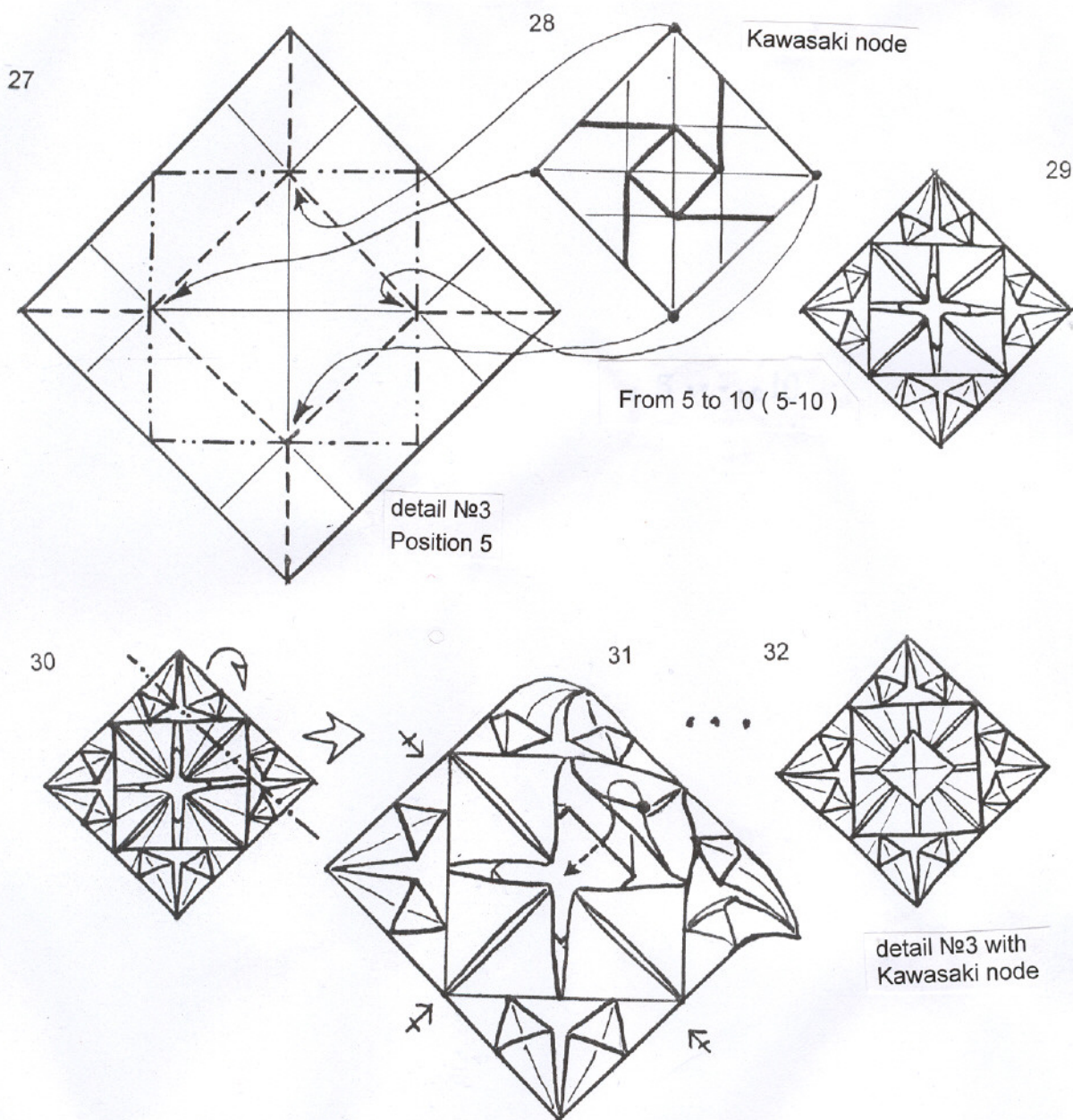

Put the outside corners of the detail №3 in the detail №2 (as it is shown on a picture), and then the outside corners of the detail №1 in the detail №1 – so the detail №4 will be made.

You should join the details by a glue-drop on the outside corners.

The detail №4 is a labour side of our fractal. We will make the three-layers kusudama of 6 details №4.



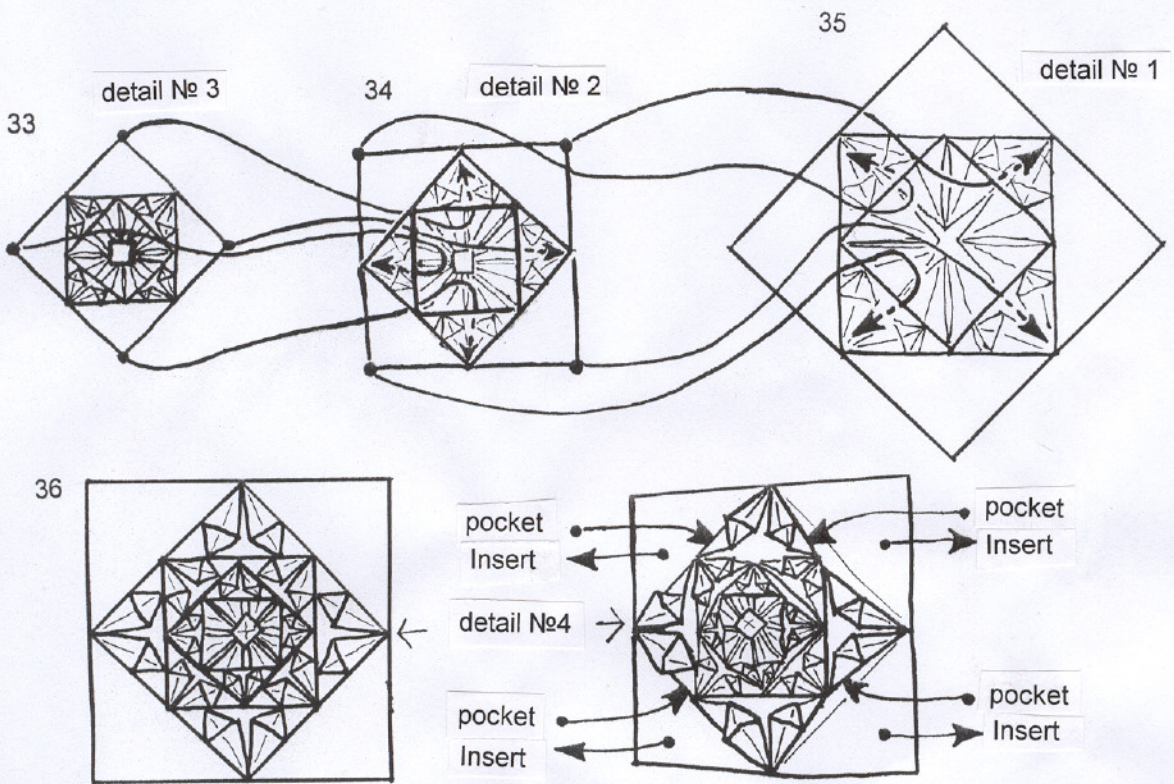

Now it is time to gather the kusudama as an ordinary cube (brick) of 6 modules. Sides of our cube have 4 insertions and 4 "pockets" unlike sides of other cubes that usually have only 2 insertions and 2 "pockets".

Put a glue-drop on insertions of 2 sides you are going to join. Put the insertion of the first side into the "pocket" of the second side, and glue the insertion of the second side to the first side (on the inner side). You should also glue a loop on the inner side of the corner, if you want your kusudama to hang.

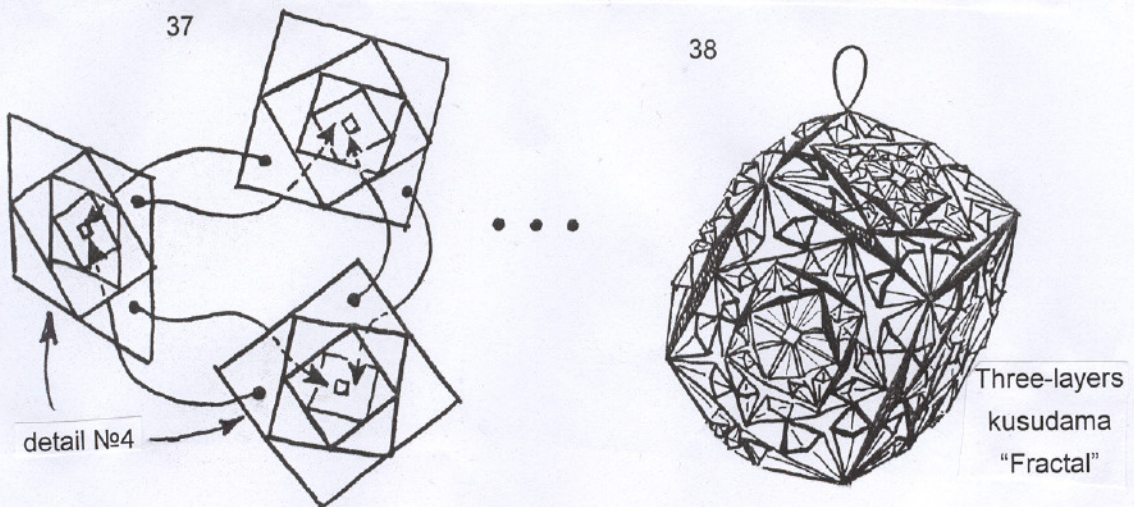

You can make every side of the kusudama three-coloured. For example, one side may be dark-blue (№1), blue (№2) and light-blue or lilac (№3), next side – dark-green (№1), green (№2) and light-green or lemon (№3), the third side - red (№1), pink (№2) and light-pink (№3).

You can make two sides of such colour or all sides can be coloured in different ways. All Kawasaki nodes should better be made bright-yellow or orange.